



**FITTING INSTRUCTIONS FOR LP0216 LICENCE PLATE BRACKET**  
**KTM 390 DUKE '14-'16-**



**THIS KIT CONTAINS THE ITEMS PICTURED AND LABELLED BELOW.**  
**DO NOT PROCEED UNTIL YOU ARE SURE ALL PARTS ARE PRESENT.**

**Please note that the way the kit is packed does not necessarily represent the way of mounting to the bike**

THE PARTS SHOWN MAY BE REPRESENTATIVE ONLY (FOR CLARITY OF INSTRUCTIONS ONLY)

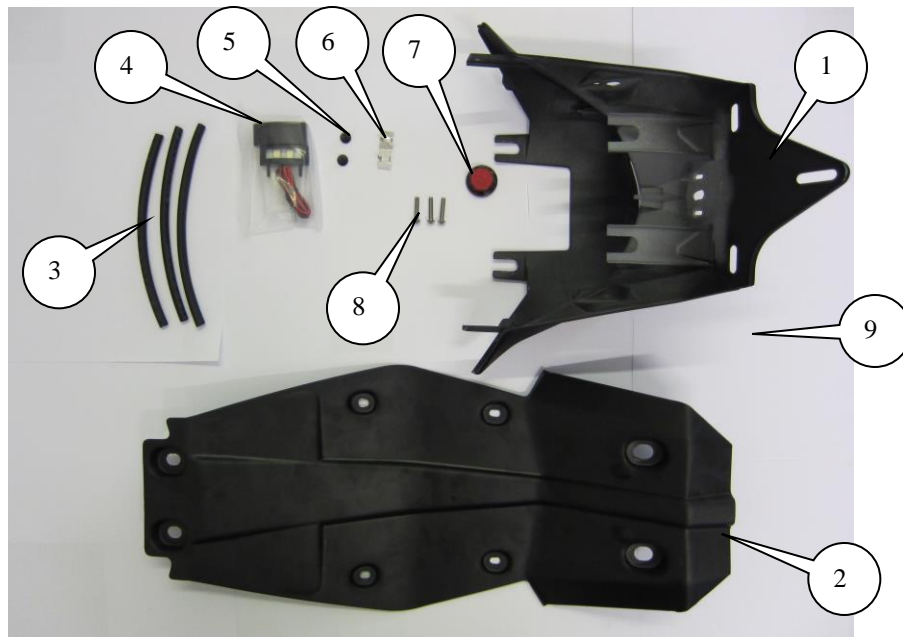



### **LEGEND**

ITEM 1 = LICENCE PLATE BRACKET (TB0108 PT 1) (x1).

ITEM 2 = UNDER-TRAY (TB0108 PT 2) (x1).

ITEM 3 = 150mm LENGTH OF HEAT SHRINK (x3).

ITEM 4 = LICENCE PLATE ILLUMINATOR TO INCLUDE CONNECTORS AND SHROUD (LA0002) (x1).

ITEM 5 = RUBBER GROMMET (RB50-20-00FG) (x2).

ITEM 6 = CABLE CLIPS (x2).

ITEM 7 = REFLECTOR (x1).

ITEM 8 = M4x20mm LONG BUTTON HEAD BOLTS (x3).

ITEM 9 = M6x16mm LONG BUTTON HEAD BOLTS (x2).

ITEM 10 = M6 WASHERS (x2).

ITEM 11 = M10 WASHERS (x2).

ITEM 12 = LA0008 TAIL LIGHT ASSEMBLY (x1).

Please note that in cases where kits are packed with rubber washers holding the components onto the bolt – *the rubber washers should be thrown away!*

### **TOOLS REQUIRED**

- Socket set to include 10mm A/F socket and wrench.
  - 2.5mm and 4mm Allen keys.
    - 14mm spanner.
  - Phillips screw-driver.
  - Electrical pliers/crimps.
    - Super glue.

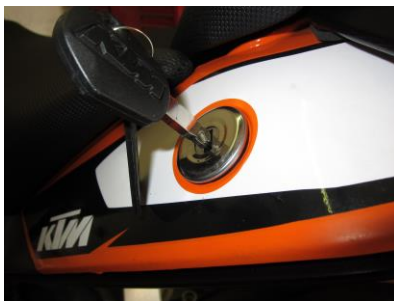

PICTURE 1

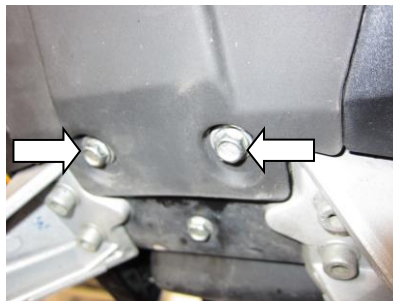

PICTURE 2



PICTURE 3

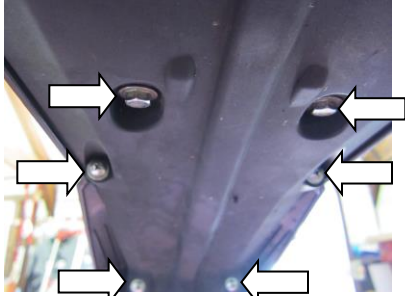

PICTURE 4

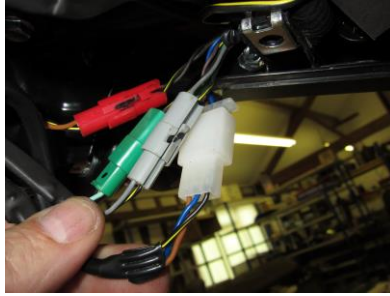

PICTURE 5



PICTURE 6



PICTURE 7

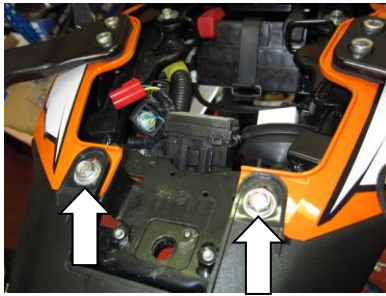

PICTURE 8



PICTURE 9



PICTURE 10



PICTURE 11

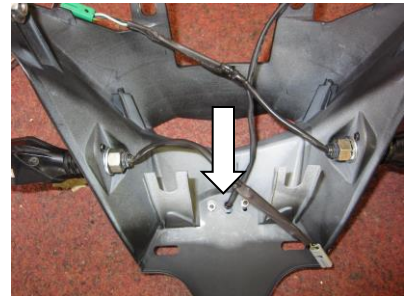

PICTURE 12

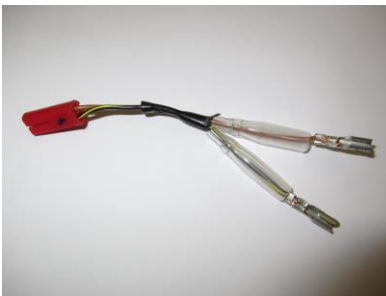

PICTURE 13



### **FITTING INSTRUCTIONS**

- REMOVE PILLION SEAT USING KEY (SEE PICTURE 1).
- UNDO AND REMOVE THE EIGHT BOLTS AND FOUR SCREWS/WASHERS HOLDING THE ORIGINAL UNDER-TRAY IN PLACE AS SHOWN IN PICTURES 2, 3 AND 4.
- REMOVE THE ORIGINAL UNDER-TRAY.
- DISCONNECT THE ELECTRICAL PLUG SOCKETS FOR LICENCE PLATE ILLUMINATOR, INDICATORS AND REAR LIGHT (AS SHOWN IN PICTURE 5).
- REMOVE THE FOUR BOLTS HOLDING THE REAR LIGHT SURROUND SHOWN IN PICTURES 6, 7 AND 8.
- REMOVE THE REAR LIGHT AND REAR LIGHT SURROUND.
- UNDO AND REMOVE THE THREE BOLTS HOLDING THE REAR LIGHT IN POSITION AND REMOVE THE REAR LIGHT. THIS WILL NO LONGER BE REQUIRED AND A NEW LIGHT (ITEM 12) HAS BEEN SUPPLIED IN THE KIT.
- FIT NEW LICENCE PLATE ILLUMINATOR TO NEW LICENCE PLATE BRACKET (SEE PICTURE 12). WE SUGGEST CUTTING AND REUSING ORIGINAL PLUG SOCKET (AS SHOWN IN PICTURES 5 AND 13). PROTECT THE WIRES USING THE SMALLER HEAT SHRINK FROM KIT.
  - THE ORIGINAL BROWN WIRE -----NEW RED WIRE.
  - THE ORIGINAL BLACK/YELLOW WIRE (EARTH) -----NEW BLACK WIRE.
- **PLEASE NOTE YOU WILL NEED TO GLUE THE LIGHT SHROUD TO THE LED LICENCE PLATE ILLUMINATOR BEFORE FITTING USING SUPER GLUE (SEE TOP PICTURE).**
- REMOVE THE TWO CLIP NUTS AS SHOWN IN PICTURE 11 AND PLACE ON THE CORRESPONDING POSITIONS ON THE NEW LICENCE PLATE BRACKET.
- FIT INDICATORS (TURN SIGNALS) OF YOUR CHOICE TO NEW LICENCE PLATE BRACKET. IF FITTING MINI'S, R&G PRODUCT CODE RG370 (IF USING THESE NO RESISTORS ARE REQUIRED) THERE ARE GOMMETS SUPPLIED TO BLANK OFF UNUSED HOLE IN LICENCE PLATE BRACKET.
  - PLEASE NOTE: GREY PLUG SOCKET=RIGHT HAND INDICATOR (TURN SIGNAL).
  - : GREEN PLUG SOCKET=LEFT HAND INDICATOR (TURN SIGNAL).
- FIT THE NEW REAR LIGHT (ITEM 12) TO THE NEW LICENCE PLATE BRACKET USING THE THREE M4 BOLTS FROM KIT AND THREE OF THE WASHERS REMOVED FROM THE UNDER-TRAY SECURING BOLTS.
- OFFER THE NEW LICENCE PLATE BRACKET INTO POSITION AND SECURE AS ORIGINAL USING THE FOUR ORIGINAL BOLTS (FEED THE WIRING THROUGH THE HOLE IN THE REAR SUB-FRAME AS ORIGINAL).
- RECONNECT ALL WIRING PLUG SOCKETS AS ORIGINAL (IT IS A GOOD IDEA TO CHECK THE OPERATION OF ALL LIGHTS AT THIS STAGE).
- OFFER THE NEW UNDER-TRAY INTO POSITION AND SECURE USING THE ORIGINAL BOLTS EXCEPT THE TWO MOST FORWARD/LOWEST MOUNTING HOLES (AS SHOWN IN PICTURE 2). ON THESE HOLES PLACE ONE OF THE M10 WASHERS OVER EACH LOCATING SPIGOT, THEN USE THE TWO M6x16mm LONG BUTTON HEAD BOLTS AND WASHERS FROM KIT TO SECURE.
- REFIT LICENCE PLATE (IT MAY REQUIRE DRILLING).
- **IMPORTANT: IF FITTING A FULL-SIZE LICENCE PLATE AND PLACING IT FAR DOWN ON THE LICENCE PLATE HANGER, THERE IS A SMALL CHANCE**

R&G Racing

Unit 1, Shelley's Lane, East Worldham, Alton, Hampshire, GU34 3AQ

Tel: +44 (0)1420 89007 Fax: +44 (0)1420 87301 [www.rg-racing.com](http://www.rg-racing.com) Email: [info@rg-racing.com](mailto:info@rg-racing.com)





**OF THE LICENCE PLATE HITTING THE BACK WHEEL UNDER HEAVY LOAD AND OVER LARGE BUMPS IN THE ROAD. IT IS YOUR RESPONSIBILITY TO CHECK FOR THIS POSSIBILITY AND TAKE AVOIDING ACTION. FAILURE TO CHECK THIS COULD RESULT IN SERIOUS INJURY.**

- REFIT SEAT.
- DEPENDING ON LOCAL LAWS, ATTACH ENCLOSED REFLECTOR IN AN APPROPRIATE LOCATION.
- TEST THE LICENCE PLATE ILLUMINATOR AND ALL LIGHTS BEFORE RIDING.

Issue 2 01/03/2017 (AR)

#### **CONSUMER NOTICE**

The catalogue description and any exhibition of samples are only broad indications of the Products and R&G may make design changes which do not diminish their performance or visual appeal and supplying them in such state shall conform to the order. The Buyer acknowledges no representation or warranty (other than as to title) has been given or will apply to the Products other than those in R&G's order or confirmation and the Buyer confirms it has chosen the Products as being of merchantable quality and suitable for its particular purposes. Where R&G fits the Products or undertakes other services it shall exercise reasonable skill and care and rectify any fault free of charge unless the workmanship has been disturbed. The Buyer is responsible for ensuring that the warranty on the motorcycle is not affected by the fitting of the Products. On return of any defective Products R&G shall at its option either supply a replacement or refund the purchase money but shall not be liable if the Products have been modified or used or maintained otherwise than in accordance with R&G's or manufacturer's instructions and good engineering practice or if the defect arises from accident or neglect. Other than identified above and subject to R&G not limiting its liability for causing death and personal injury, it shall not be liable for indirect or consequential loss and otherwise its liability shall be limited to the amounts paid by the Buyer for the Products or the fitting or service concerned. These terms do not affect the Buyer's statutory rights.

#### **R&G RACING RETURNS POLICY (NON-FAULTY GOODS)**

Returns must be pre-authorized (if not pre-authorized the return will be rejected). Goods may only be returned direct to us if they were purchased direct from us (customer must prove if necessary). Otherwise to be returned to original vendor. Goods must be in resellable condition, in the opinion of R&G Racing. All returns are subject to a 25% restocking and handling fee (25% of the gross value exc. P&P – at the prevailing price at time of purchase). The customer must pay any and all carriage charges. No returns of discontinued products, unless within 14 days of purchase. This policy does not affect your statutory rights and does not refer to faulty goods.

R&G Racing

Unit 1, Shelley's Lane, East Worldham, Alton, Hampshire, GU34 3AQ

Tel: +44 (0)1420 89007 Fax: +44 (0)1420 87301 [www.rg-racing.com](http://www.rg-racing.com) Email: [info@rg-racing.com](mailto:info@rg-racing.com)



**NOTICE DE MONTAGE POUR LP0216 SUPPORT DE PLAQUE**  
**KTM 390 DUKE '14-'16-**



**Assurez vous que toutes les pièces soient présentes avant de procéder au montage.**

**La façon dont le kit est emballé ne correspond pas forcément à la façon de monter les pièces sur la moto.**

LES PIÈCES PRÉSENTÉES PEUVENT N'ÊTRE QUE REPRÉSENTATIVES, AFIN DE FACILITER ET CLARIFIER LES INSTRUCTIONS DE MONTAGE.

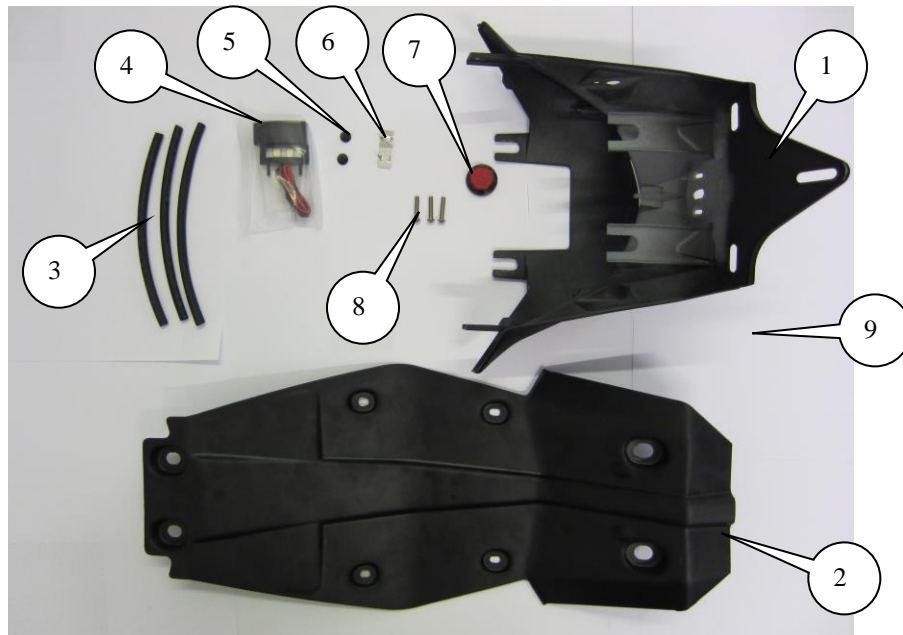



### LEGENDE

- ARTICLE 1 = SUPPORT DE PLAQUE (TB0108 PT 1) (x1).  
ARTICLE 2 = SOUS PLAQUE (TB0108 PT 2) (x1).  
ARTICLE 3 = 150mm BANDEAU THERMO RETRACTABLE (x3).  
ARTICLE 4 = FEU DE PLAQUE & LINCEUL (LA0002) (x1).  
ARTICLE 5 = OEILLET EN CAOUTCHOUC (RB50-20-00FG) (x2).  
ARTICLE 6 = CLIPS CABLE (x2).  
ARTICLE 7 = REFLECTEUR (x1).  
ARTICLE 8 = M4x20mm BOULONS (x3).  
ARTICLE 9 = M6x16mm BOULONS (x2).  
ARTICLE 10 = M6 RONDELLES (x2).  
ARTICLE 11 = M10 RONDELLES (x2).  
ARTICLE 12 = LA0008 ASSEMBLAGE FEU DE PLAQUE (x1).

Notez que si les kits sont emballés avec des rondelles en caoutchouc servant à tenir les composants, *ces rondelles doivent être jetées!*

### OUTILS REQUIS

- Clé à cliquet + douilles de 10mm.
- Clés Allen 2.5mm et 4mm.
  - Clé à molette 14mm.
- Tournevis cruciforme.
  - Pincés électrique
  - Super glue.



PHOTO 1

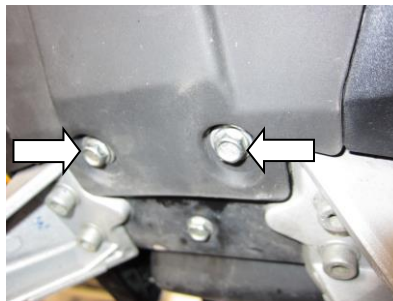

PHOTO 2



PHOTO 3

R&G Racing

Unit 1, Shelley's Lane, East Worldham, Alton, Hampshire, GU34 3AQ

Tel: +44 (0)1420 89007 Fax: +44 (0)1420 87301 [www.rg-racing.com](http://www.rg-racing.com) Email: [info@rg-racing.com](mailto:info@rg-racing.com)

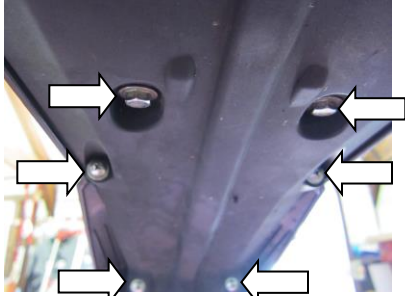

PHOTO 4

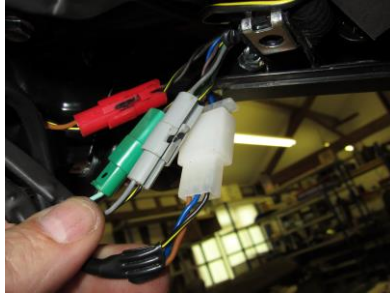

PHOTO 5



PHOTO 6



PHOTO 7

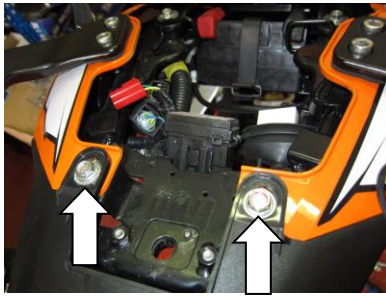

PHOTO 8



PHOTO 9



PHOTO 10



PHOTO 11

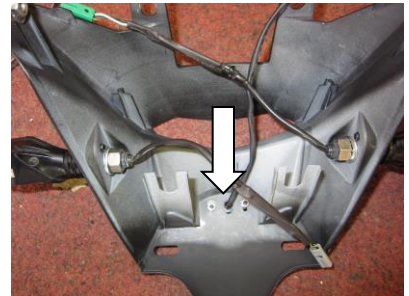

PHOTO 12

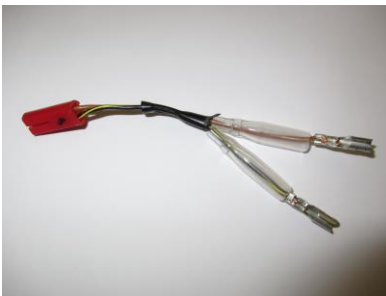

PHOTO 13





## NOTICE DE MONTAGE

- ENLEVER LE SIEGE PASSAGER A L'AIDE DE LA CLE (VOIR PHOTO 1).
- ENLEVER LES 8 BOULONS ET 4 VIS/RONDELLES QUI FIXENT LE SOUS PLAQUE D'ORIGINE EN PLACE, VOIR PHOTOS 2, 3 ET 4.
- ENLEVER LE SOUS PLAQUE D'ORIGINE.
- DECONNECTER LES PRISES ELECTRIQUES DU FEU DE PLAQUE, DES CLIGNOTANTS ET DU FEU ARRIERE (VOIR PHOTO 5).
- ENLEVER LES 4 BOULONS QUI FIXENT LE CONTOUR DE FEU ARRIERE, VOIR PHOTOS 6, 7 AND 8.
- ENLEVER LE FEU ARRIERE ET SON CONTOUR.
- ENLEVER LES 3 BOULONS QUI FIXENT LE FEU ARRIERE EN POSITION PUIS ENLEVER LE FEU ARRIERE. IL NE SERA PLUS UTILE CAR UN NOUVEAU FEU EST FOURNI DANS LE KIT (ARTICLE 12).
- MONTER LE NOUVEAU FEU DE PLAQUE SUR LE NOUVEAU SUPPORT DE PLAQUE (VOIR PHOTO 12). NOUS SUGGERONS DE COUPER PUIS REUTILISER LA PRISE D'ORIGINE (VOIR PHOTOS 5 ET 13). PROTEGER LES FILS EN UTILISANT LES MANCHONS THERMO RETRACTABLE DU KIT.

LE FIL MARRON D'ORIGINE -----NOUVEAU FIL ROUGE.

LE FIL NOIR/JAUNE D'ORIGINE (TERRE) -----NOUVEAU FIL NOIR.

- **NOTE : VOUS DEVREZ ENGLUER LE LINCEUL DE FEU AU FEU DE PLAQUE AVANT DE LE COLLER (VOIR PHOTO DU DESSUS).**
- ENLEVER LES 2 ECROUS, VOIR PHOTO 11 ET PLACEZ LES DANS LES POSITIONS CORRESPONDANTES SUR LE NOUVEAU SUPPORT DE PLAQUE.
- MONTER LES CLIGNOTANTS (TOURNEZ LES SIGNAUX) DE VOTRE CHOIX SUR LE NOUVEAU SUPPORT DE PLAQUE. SI VOUS MONTEZ LES MINI CLIGNOTANTS R&G, CODE RG370 (SI VOUS LES UTILISEZ, VOUS N'AVEZ PAS BESOIN DE RESISTANCES) IL Y A DES OEILLETES FOURNIS POUR OBTURER LE TROU DE SUPPORT DE PLAQUE.  
NOTE: PRISE GRISE=CLIGNOTANT COTE DROIT (SIGNAL).  
      : PRISE VERTE=CLIGNOTANT COTE GAUCHE (SIGNAL).
- MONTER LE NOUVEAU FEU ARRIERE (ARTICLE 12) SUR LE NOUVEAU SUPPORT DE PLAQUE A L'AIDE DES 3 BOULONS M4 DU KIT ET 3 RONDELLES ENLEVEES DES BOULONS DU SOUS PLAQUE.
- MONTER LE NOUVEAU SUPPORT DE PLAQUE EN POSITION ET FIXER COMME A L'ORIGINE A L'AIDE DES 4 BOULONS D'ORIGINE (PASSER LES FILS DANS LE TROU DU SOUS-PLATEAU ARRIERE COMME A L'ORIGINE).
- RECONNECTER TOUTES LES PRISES DE FILS COMME A L'ORIGINE (IL EST JUDICIEUX DE VERIFIER LE FONCTIONNEMENT DES TOUS LES FEUX A CE STADE).
- MONTER LE NOUVEAU SOUS PLATEAU EN POSITION PUIS FIXER A L'AIDE DES BOULONS D'ORIGINE EXCEPTES LES 2 PLUS EN AVANT/TROUS DE FIXATION LES PLUS BAS (VOIR PHOTO 2). SUR CES TROUS, PLACEZ UN RONDELLE M10 SUR CHAQUE RESSORT, PUIS UTILISER LES 2 BOULONS M6x16mm DE LONG ET RONDELLES DU KIT POUR FIXER.
- MONTER LA PLAQUE D'IMMATRICULATION SUR LE NOUVEAU SUPPORT DE PLAQUE (ARTICLE 4)(CETTE OPERATION PEUT NECESSITER UN PERCAGE).
- **IMPORTANT: SI VOUS INSTALLEZ UNE GROSSE PLAQUE, IL Y A UN RISQUE QUE LA PLAQUE ENTRE EN CONTACT AVEC LA ROUE ARRIERE EN CAS DE BOSSE OU DE CHOC SUR LA**

R&G Racing

Unit 1, Shelley's Lane, East Worldham, Alton, Hampshire, GU34 3AQ

Tel: +44 (0)1420 89007 Fax: +44 (0)1420 87301 [www.rg-racing.com](http://www.rg-racing.com) Email: [info@rg-racing.com](mailto:info@rg-racing.com)



**ROUTE. IL EST DE VOTRE RESPONSABILITE DE VERIFIER QUE CELA NE PUISSE PAS SE PRODUIRE. NE PAS EFFECTUER CES VERIFICATIONS PEUT ENTRAINER DES DOMMAGES AINSI QUE DES BLESSURES GRAVES POUR LE PILOTE.**

- REMETTRE LE SIEGE.
- SELON LA LOI LOCALE, ATTACHEZ LE REFLECTEUR FOURNI A SON EMPLACEMENT APPROPRIE.
- **VERIFIEZ QUE LES CLIGNOTANTS ET LES FEUX DE PLAQUE FONCTIONNENT BIEN AVANT DE PRENDRE LA ROUTE.**

Issue 2 01/03/2017 (AR)

#### **CONSUMER NOTICE**

The catalogue description and any exhibition of samples are only broad indications of the Products and R&G may make design changes which do not diminish their performance or visual appeal and supplying them in such state shall conform to the order. The Buyer acknowledges no representation or warranty (other than as to title) has been given or will apply to the Products other than those in R&G's order or confirmation and the Buyer confirms it has chosen the Products as being of merchantable quality and suitable for its particular purposes. Where R&G fits the Products or undertakes other services it shall exercise reasonable skill and care and rectify any fault free of charge unless the workmanship has been disturbed. The Buyer is responsible for ensuring that the warranty on the motorcycle is not affected by the fitting of the Products. On return of any defective Products R&G shall at its option either supply a replacement or refund the purchase money but shall not be liable if the Products have been modified or used or maintained otherwise than in accordance with R&G's or manufacturer's instructions and good engineering practice or if the defect arises from accident or neglect. Other than identified above and subject to R&G not limiting its liability for causing death and personal injury, it shall not be liable for indirect or consequential loss and otherwise its liability shall be limited to the amounts paid by the Buyer for the Products or the fitting or service concerned. These terms do not affect the Buyer's statutory rights.

#### **R&G RACING RETURNS POLICY (NON-FAULTY GOODS)**

Returns must be pre-authorized (if not pre-authorized the return will be rejected). Goods may only be returned direct to us if they were purchased direct from us (customer must prove if necessary). Otherwise to be returned to original vendor. Goods must be in re-sellable condition, in the opinion of R&G Racing. All returns are subject to a 25% restocking and handling fee (25% of the gross value exc. P&P – at the prevailing price at time of purchase). The customer must pay any and all carriage charges. No returns of discontinued products, unless within 14 days of purchase. This policy does not affect your statutory rights and does not refer to faulty goods.

R&G Racing

Unit 1, Shelley's Lane, East Worldham, Alton, Hampshire, GU34 3AQ

Tel: +44 (0)1420 89007 Fax: +44 (0)1420 87301 [www.rg-racing.com](http://www.rg-racing.com) Email: [info@rg-racing.com](mailto:info@rg-racing.com)



**MONTAGEANLEITUNG FÜR LP0108 KENNZEICHENHALTER**  
**KTM 390 DUKE MODELL '14-'16-**



**ALLE GELIEFERTEN TEILE SIND UNTEN ABGEBILDET UND GEKENNZEICHNET. BEVOR SIE MIT DER MONTAGE BEGINNEN, ÜBERPRÜFEN SIE SORGFÄLTIG, DASS ALLE TEILE VORHANDEN SIND.**

**Hinweis: Die Verpackung der Teile stellt nicht die Reihenfolge der Montage dar.**

**DIE UNTEN ABGEBILDETEN TEILE DIENEN LEDIGLICH ZUR ERKLÄRUNG**

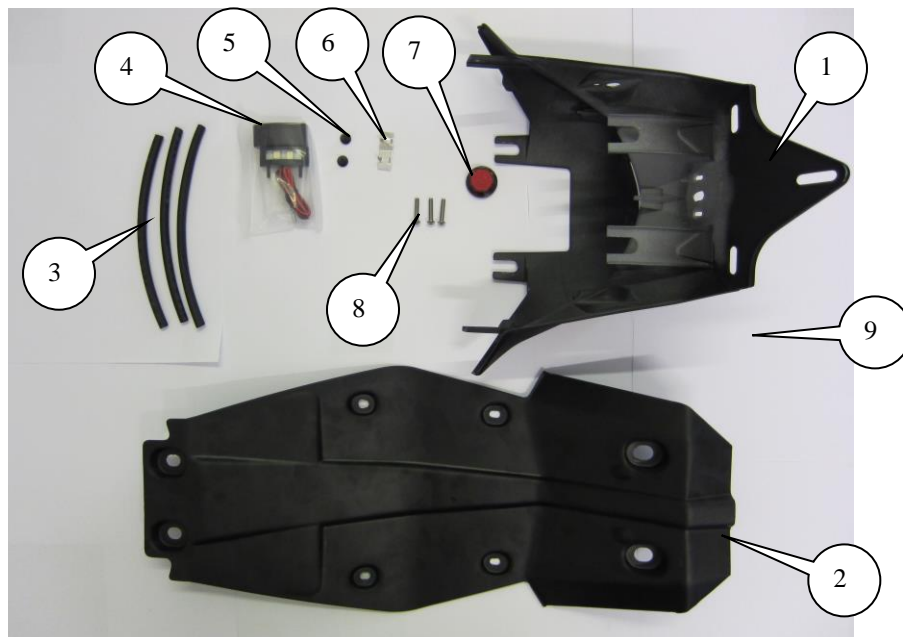



### **LIEFERUMFANG**

- ARTIKEL 1 = KENNZEICHENHALTER (TB0108 PT 1) (x1).
- ARTIKEL 2 = UNTERE ABDECKUNG (TB0108 PT 2) (x1).
- ARTIKEL 3 = 150mm SCHRUMPFSCHLAUCH (x3).
- ARTIKEL 4 = KENNZEICHENBELEUCHTUNG (LA0002) (x1).
- ARTIKEL 5 = GUMMITÜLLE (RB50-20-00FG) (x2).
- ARTIKEL 6 = KABELCLIPS (x2).
- ARTIKEL 7 = RÜCKSTRAHLER (x1).
- ARTIKEL 8 = M4x20mm INBUSSCHRAUBEN (x3).
- ARTIKEL 9 = M6x16mm INBUSSCHRAUBEN (x2).
- ARTIKEL 10 = M6 UNTERLEGSscheIBEN (x2).
- ARTIKEL 11 = M10 UNTERLEGSscheIBEN (x2).
- ITEM 12 = LA0008 TAIL LIGHT ASSEMBLY (x1).

Hinweis für Kits mit Plastikunterlegscheiben an den Schrauben – *Diese Plastikunterlegscheiben werden nicht für den Einbau benötigt!*

### **SIE BENÖTIGEN FOLGENDES WERKZEUG:**

- 10mm Steckschlüssel
- Satz Inbusschlüssel inkl. 2.5mm und 4mm Größe A/F
- 14mm Gabelschlüssel
- Kreuzschlitzschraubendreher
  - Elektriker Zange
  - Sekundenkleber



ABBILDUNG 1



ABBILDUNG 2



ABBILDUNG 3



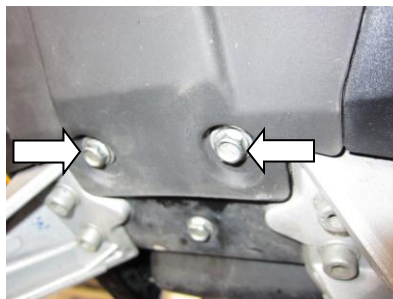

ABBILDUNG 4



ABBILDUNG 5

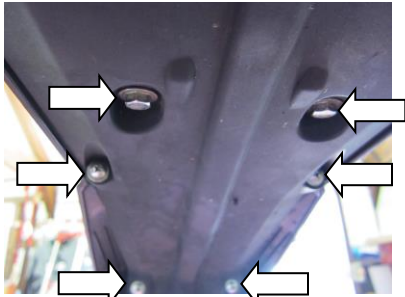

ABBILDUNG 6

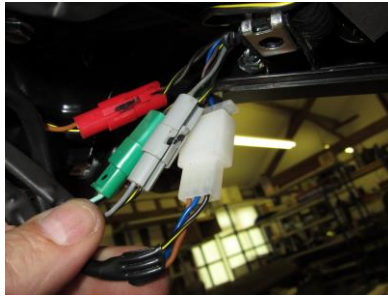

ABBILDUNG 7



ABBILDUNG 8



ABBILDUNG 9

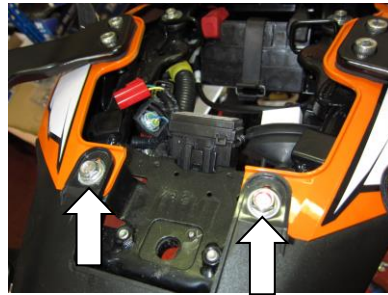

ABBILDUNG 10



ABBILDUNG 11



ABBILDUNG 12



ABBILDUNG 13

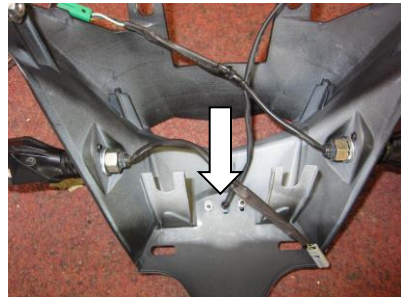

## MONTAGEANLEITUNG

- ENTFERNEN SIE DEN SITZ MITTELS SCHLÜSSEL (SIEHE ABBILDUNG 1).
- LÖSEN UND ENTFERNEN SIE DIE ACHT SCHRAUBEN UND VIER SCHRAUBEN/UNTERLEGSCHLEIBEN, DIE DIE UNTERE ABDECKUNG BEFESTIGEN (ABBILDUNGEN 2, 3 UND 4).
- ENTFERNEN SIE DIE UNTERE ABDECKUNG.
- TRENNEN SIE DIE ELEKTRISCHEN STECKVERBINDER FÜR DIE KENNZEICHENBELEUCHTUNG, DIE BLINKER UND DAS RÜCKLICHT (ABBILDUNG 5).
- ENTFERNEN SIE DIE VIER SCHRAUBEN, DIE DIE RÜCKLICHTVERKLEIDUNG BEFESTIGEN (ABGEBILDET IN ABBILDUNGEN 6, 7 UND 8).
- ENTFERNEN SIE DAS RÜCKLICHT UND DIE RÜCKLICHTVERKLEIDUNG.
- LÖSEN UND ENTFERNEN SIE DIE DREI SCHRAUBEN, DIE DAS RÜCKLICHT IN POSITION HALTEN UND ENTFERNEN SIE DAS RÜCKLICHT.
- MONTIEREN SIE DIE NEUE KENNZEICHENBELEUCHTUNG AM NEUEN KENNZEICHENHALTER (ABBILDUNG 12). WIR EMPFEHLEN, DEN ORIGINAL STECKVERBINDER ABZUTRENNEN UND WIEDER ZU VERWENDEN (WIE IN ABBILDUNGEN 5 UND 13 ABGEBILDET). VERWENDEN SIE DEN KLEINEREN SCHRUMPFSCHLAUCH VOM KIT, UM DIE KABEL ZU SCHÜTZEN.

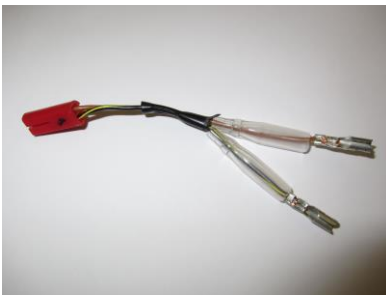
ORIGINAL BRAUNES KABEL ----- NEUES ROTE KABEL.

ORIGINAL SCHWARZ/GELB KABEL (MASSE) ----- NEUES SCHWARZE KABEL

- **BITTE BEACHTEN: VOR MONTAGE MUSS DIE LICHTABDECKUNG MIT SEKUNDENKLEBER AN DER LED-KENNZEICHENBELEUCHTUNG GEKLEBT WERDEN (SIEHE OBERE ABBILDUNG).**
- ENTFERNEN SIE DIE ZWEI KLIPPMUTTER (ABBILDUNG 11) UND MONTIEREN SIE DIE AUF DEN ENTSPRECHENDEN POSITIONEN AM NEUEN KENNZEICHENHALTER.
- MONTIEREN SIE DIE BLINKER IHRER WAHL AM NEUEN KENNZEICHENHALTER. WENN SIE R&G MINI-BLINKER (ARTIKEL-NR. RG370) MONTIEREN (WENN SIE DIE VERWENDEN, BENÖTIGEN SIE KEINE WIDERSTÄNDE), VERWENDEN SIE DIE MITGELIEFERTEN GUMMITÜLLEN, UM DAS UNBENUTZTE LOCH IM KENNZEICHENHALTER ZU VERSCHLIESSEN.

HINWEIS: GRAUES STECKVERBINDER=RECHTER BLINKER

GRÜNES STECKVERBINDER=LINKER BLINKER

- MONTIEREN SIE DAS RÜCKLICHT AM NEUEN KENNZEICHENHALTER. VERWENDEN SIE DIE DREI M4 SCHRAUBEN VOM KIT UND DIE DREI UNTERLEGSCHLEIBEN, DIE VON DEN SICHERUNGSSCHRAUBEN AN DER UNTEREN ABDECKUNG ENTFERNT WURDEN.
- HALTEN SIE DEN NEUEN KENNZEICHENHALTER IN POSITION UND MIT DEN VIER ORIGINALSCHRAUBEN BEFESTIGEN (FÜHREN SIE DIE VERKABELUNG DURCH DAS LOCH IM HECKRAHMEN, WIE URSPRÜNGLICH).
- VERBINDEN SIE ALLE KABELSTECKVERBINDER (WIE URSPRÜNGLICH). ÜBERPRÜFEN SIE DIE FUNKTION DER BELEUCHTUNG.
- DIE NEUE UNTERE ABDECKUNG IN POSITION BRINGEN UND MIT DEN ORIGINALSCHRAUBEN BEFESTIGEN – NUR DIE BEIDEN VORDEREN/NIEDRIGEN MONTAGELÖCHER NICHT (SIEHE ABBILDUNG 2). AN DIESEN LÖCHERN JEWEILS EINE M10 UNTERLEGSCHLEIBE VERWENDEN UND MIT DEN ZWEI M6x16mm INBUSSCHRAUBEN VOM KIT BEFESTIGEN.
- MONTIEREN SIE DEN KENNZEICHENHALTER (BOHRUNGEN IM KENNZEICHEN EVTL. NOTWENDIG).
- **WICHTIG: WENN EIN GROSSES KENNZEICHEN ZU WEIT NACH UNTEN MONTIERT WIRD, BESTEHT BEI SCHWEREM LAST ODER DURCH GROSSE BODENWELLEN EIN GERINGES RISIKO, DASS DAS KENNZEICHEN AN DAS HINTERRAD STOSSEN KANN. ES LIEGT IN IHRER VERANTWORTUNG DIES ZU ÜBERPRÜFEN UND, WENN**

R&G Racing

Unit 1, Shelley's Lane, East Worldham, Alton, Hampshire, GU34 3AQ

Tel: +44 (0)1420 89007 Fax: +44 (0)1420 87301 [www.rg-racing.com](http://www.rg-racing.com) Email: [info@rg-racing.com](mailto:info@rg-racing.com)



**NOTWENDIG, VORZUBEUGENDE MASSNAHMEN ZU ERGREIFEN. DIE NICHTBEACHTUNG DIESES SICHERHEITSHINWEIS KANN ZU SCHWEREN VERLETZUNGEN FÜHREN.**

- MONTIEREN SIE DEN SITZ.
- ENTSPRECHEND DER GESETZLICHEN VORSCHRIFTEN, DEN MITGELIEFERTEN RÜCKSTRAHLER AN DIE DAFÜR VORGESEHENE STELLE ANBRINGEN.
- ÜBERPRÜFEN SIE DIE FUNKTION DER BELEUCHTUNG (BLINKER UND KENNZEICHENHALTERBELEUCHTUNG) VOR GEBRAUCH DES FAHRZEUGES.

Ausgabe 2 01/03/2017 (AR)